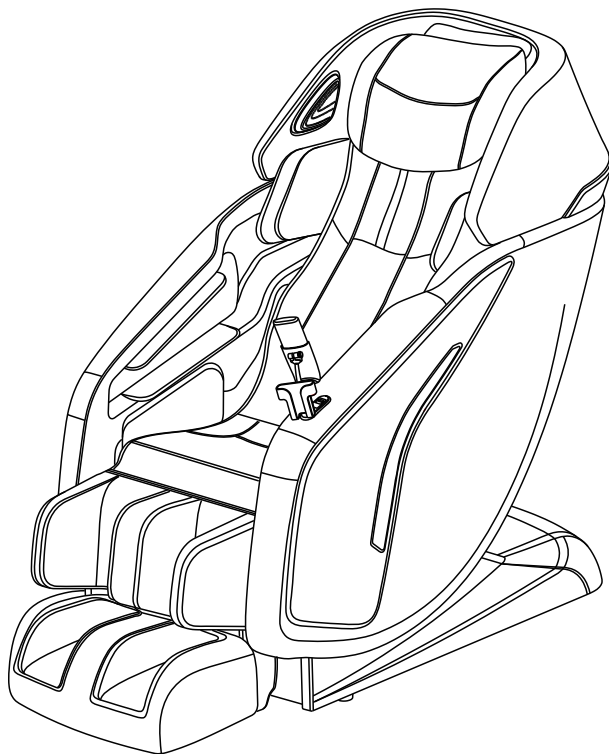


COSTWAY

Clear Bay Swedish T Revive



USER'S MANUAL

Massage Chair

JL10005WL

THIS INSTRUCTION BOOKLET CONTAINS **IMPORTANT** SAFETY INFORMATION. PLEASE READ AND KEEP FOR FUTURE REFERENCE.

Please give us a chance to make it right and do better!

Contact our friendly customer service department for help first.

Replacements for missing or damaged parts will be shipped ASAP!

Follow Costway



Contact Us!

Do NOT return this item.

Contact our friendly customer service department for help first.



Before You Start

- ⚠ Please read all instructions carefully.
- ⚠ Retain instructions for future reference.
- ⚠ Separate and count all parts and hardware.
- ⚠ Read through each step carefully and follow the proper order.
- ⚠ We recommend that, where possible, all items are assembled near to the area in which they will be placed in use, to avoid moving the product unnecessarily once assembled.
- ⚠ Always place the product on a flat, steady and stable surface.
- ⚠ Keep all small parts and packaging materials for this product away from babies and children as they potentially pose a serious choking hazard.

The Company reserves the right to make improvements to the products and to explain improvements. The product is subject to change without prior notice. The appearance of the product is based on the physical object.

FC CCAUTION

This device complies with part 15 of the FCC Rules. Operation is subject to the following two conditions:

(1) This device may not cause harmful interference, and (2) this device must accept any interference received, including interference that may cause undesired operation.

Any changes or modifications not expressly approved by the party responsible for compliance could void the user's authority to operate the equipment.

NOTE: This equipment has been tested and found to comply with the limits for a Class B digital device, pursuant to part 15 of the FCC Rules. These limits are designed to provide reasonable protection against harmful interference in a residential installation. This equipment generates, uses and can radiate radio frequency energy and, if not installed and used in accordance with the instructions, may cause harmful interference to radio communications. However, there is no guarantee that interference will not occur in a particular installation. If this equipment does cause harmful interference to radio or television reception, which can be determined by turning the equipment off and on, the user is encouraged to try to correct the interference by one or more of the following measures:

- Reorient or relocate the receiving antenna.
- Increase the separation between the equipment and receiver.
- Connect the equipment into an outlet on a circuit different from that to which the receiver is connected.
- Consult the dealer or an experienced radio/TV technician for help.

The equipment complies with FCC radiation exposure limits set forth for an uncontrolled environment,

This transmitter must not be co-located or operating in conjunction with any other antenna or transmitter.

The equipment should be installed and operated with minimum distance 8" (20cm) between the radiator and your body.

IC WARNING

This device complies with Industry Canada licence-exempt RSS standard(s). Operation is subject to the following two conditions: (1) this device may not cause interference, and (2) this device must accept any interference, including interference that may cause undesired operation of the device.

Le présent appareil est conforme aux CNR d'Industrie Canada applicables aux appareils radio exempts de licence. L'exploitation est autorisée aux deux conditions suivantes : (1) l'appareil ne doit pas produire de brouillage, et (2) l'utilisateur de l'appareil doit accepter tout brouillage radioélectrique subi, même si le brouillage est susceptible d'en compromettre le fonctionnement.

This Class B digital apparatus complies with Canadian ICES-003.
The device is compliance with RF exposure guidelines, user can obtain Canadian information on RF exposure and compliance. The equipment should be installed and operated with minimum distance 8" (20cm) between the radiator and your body.

Cet appareil numérique de la classe B est conforme à la norme NMB-003 du Canada.
Après examen de ce matériel aux conformité ou aux limites d'intensité de champ RF,
Les utilisateurs peuvent sur l'exposition aux radiofréquences et la conformité and compliance d'acquérir. Installation et mise en oeuvre de ce matériel devrait avec échangeur distance minimale entre 8" (20cm) ton corps.

Massage Chair

Manual Book

Important Safety Instructions
Important Safety Warnings
Chair Installation
Names of Parts and Functions
Before Each Massage
Adjustment Method of Chair
Automatic Massage Programs
Basic Posture of Massage
Manual Massage Programs
Air Pressure Programs
Other Functions
Cleaning and Storage
Troubleshooting
Maintenance
Product specification

Thank you for purchasing this product.

Please read this manual in detail before you use it to learn the correct use of this product.

Please pay special attention to important safety warnings and keep the operation manual in good condition for reference.

IMPORTANT SAFETY INSTRUCTIONS

When using an electrical appliance, basic precautions should always be followed, including the following:
Read all instructions before using (this appliance).

DANGER – To reduce the risk of electric shock:

1) Always unplug this appliance from the electrical outlet immediately after using and before cleaning.

WARNING – To reduce the risk of burns, fire, electric shock, or injury to persons:

- 1) An appliance should never be left unattended when plugged in. Unplug from outlet when not in use, and before putting on or taking off parts.
- 2) Do not operate under blanket or pillow. Excessive heating can occur and cause fire, electric shock, or injury to persons.
- 3) Close supervision is necessary when this appliance is used by, on, or near children, invalids, or disabled persons. Keep children away from extended foot support (or other similar parts).
- 4) Use this appliance only for its intended use as described in this manual. Do not use attachments not recommended by the manufacturer.
- 5) Never operate this appliance if it has a damaged cord or plug, if it is not working properly, if it has been dropped or damaged, or dropped into water. Return the appliance to a service center for examination and repair.
- 6) Do not carry this appliance by supply cord or use cord as a handle.
- 7) Keep the cord away from heated surfaces.
- 8) Never operate the appliance with the air openings blocked. Keep the air openings free of lint, hair, and the like.
- 9) Never drop or insert any object into any opening.
- 10) Do not use outdoors.
- 11) Do not operate where aerosol (spray) products are being used or where oxygen is being administered.
- 12) To disconnect, turn all controls to the off position, then remove plug from outlet.
- 13) Connect this appliance to a properly grounded outlet only. See Grounding Instructions.
- 14) Do not use massager in close proximity to loose clothing or jewelry. Keep long hair away from massager while in use.

DANGER:

- i) Never use pins or other metallic fasteners with this appliance.
- ii) Carefully examine the covering before each use. Discard the appliance if the covering shows any sign of deterioration, such as checking, blistering, or cracking.
- iii) Keep Dry – Do not operate in a wet or moist condition.

WARNING:

- i) Temperatures sufficiently high to cause burns may occur regardless of the control setting. Do not use on an infant or invalid or on a sleeping or unconscious person. Do not use on insensitive skin or on a person with poor blood circulation. Check the skin in contact with the heated area of the appliance frequently to reduce the risk of blistering.
- ii) Do Not Crush – Avoid sharp folds.

CAUTION:

To prevent electric shock, unplug before replacing the fuse and other service.

WARNING:

The maximum rated user weight (load) is 264 Lbs / 120 KGS.

WARNING:

To reduce the risk of personal injury, read and understand all the instructions before using this product.

Important Safety Warnings

- Please read this safety precaution carefully before starting to use product.
- The precautions shown here are to remind you and use this product properly to prevent you and others from being hurt or damaged.



Caution:

If used incorrectly, the user may be harmed, or the items may be harmed or damaged, which includes the damage to houses, household property, livestock, and pets.

The appliance has a heated surface. Persons insensitive to heat must be careful when using the appliance.

EXAMPLE OF ICON

	△ Indicates that there is a warning or an attention (The example on the left shows general warnings and cautions.)
	⊘ Indicates prohibited behavior (The example on the left shows that disassembly is prohibited.)
	● Indication of mandatory and instructional content (The example on the left shows unplugging)

- Please keep it in a place where you can check it at any time.



The following people must consult your doctor before using:

- Patients with cancers
- Maternal or menstrual period
- High fever
- Patients with acute illness (painful)
- Patients with osteoporosis
- Patients with perceptual disturbance
- Cardiopath
- Anemia
- Users of cardiac rhythm devices or other implanted devices
- Spine abnormalities or curvatures
- People receiving treatment or feeling physically abnormal
- For use in previously treated or injured areas
- People who need quiet
- People with severe blood circulation disorders on the feet
- Sometimes cause physical abnormalities

**ATTENTION**



Please unplug the power immediately when the product is unable to operate or abnormal, and ask the seller to check and repair to avoid electric shock, leakage, short circuit and fire.





When massaging around the neck, please pay attention to the movement of the massage roller and do not over-massage. This may cause accidents or injuries.

When lifting/declining the seat back and legrest, please make sure that there are no people, objects or pets on the back and under the legrest to avoid any injuries.

Please make sure that the chair cover is not damaged before use. (If it is damaged, stop using it immediately, unplug the power, and request repair.) In order to avoid injury or electric shock due to the damaged chair cover.



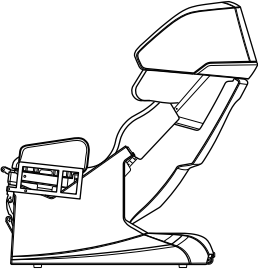
	<p>Before using, please make sure that you are not wearing any accessories to avoid injury.</p>
	<p>Please control the massage time within 15 minutes. In addition, please control the massage time of the same part within 5 minutes. Continuous massage for too long may cause muscle and nerve pain. It is recommended to control the massage time within 30 minutes for 1 day.</p>
	<p>If you have or feel any abnormalities during massage, please stop using immediately.</p>
	<p>After use, please turn of the power switch to prevent accidents caused by children playing around.</p>
	<p>Please use it in a horizontal place to avoid malfunctions and accidents.</p>
	<p>Be careful not to trip over the remote-control cable to avoid accidents or injuries.</p>
	<p>Please check the position of the massage rollers before you use it to avoid accidents or injuries.</p>
	<p>Move the chair stably to avoid scratching the surface.</p>
	<p>Do not use a power source other than 120V ~ 60Hz to avoid electric shock or sparks.</p>
	<p>If the power cord or plug is damaged, stop using it immediately to avoid electric shock, short circuit and sparks.</p>
	<p>Take care of the power cord. Do not damage, re-process, forcibly bend, stretch, twist, stick, or tighten the power cord. In addition, do not place under the heavy objects, especially do not get caught in or pinch the power cord during moving. Otherwise, the power cord may be damaged, causing electric shock or sparks.</p>
	<p>Do not allow children to use it alone and keep young children away.</p>
	<p>Do not allow children to play on the chair to avoid injury or malfunction.</p>
	<p>Do not use other therapeutic equipment while using this machine.</p>
	<p>Do not fall asleep during the massage as unconscious massage may cause injury or discomfort.</p>
	<p>Do not use it for any purpose other than massage to avoid malfunction or accident.</p>
	<p>Be sure to insert the power plug all the way, and make sure that no pins or garbage are stuck on the plug. It may cause electric shock, short circuit and fire.</p>
	<p>Do not use near open flames, such as a stove. Do not use while smoking. Do not use on heating appliances, such as electric blankets, as it may cause a fire.</p>

	<p>This appliance is not intended for use by persons (including children) with reduced physical, sensory or mental capabilities, or lack of experience and knowledge, unless they have been given supervision or instruction concerning use of the appliance by a person responsible for their safety. Children should be supervised to ensure that they do not play with the appliance.</p>
	<p>Do not pull the leather too hard. Do not puncture it with force or sharp objects to avoid injury and malfunction.</p>
	<p>Do not wipe with gasoline, diluent, etc. Do not spray insecticide to avoid electric shock and sparks.</p>
	<p>Do not sit on the backrest, armrest, or legrest to avoid injury or malfunction.</p>
	<p>Do not move the casters or drag the chair on the surface that is easy to be scratched, such as wooden floors or carpets.</p>
	<p>Do not drop the chair or hit it with strong force to avoid injury or malfunction.</p>
	<p>Do not use the chair right after a meal to avoid discomfort.</p>
	<p>Do not move the chair when carrying people or objects to avoid injury or malfunction.</p>
	<p>Do not seat more than two people on the chair at the same time to avoid injury or malfunction.</p>
	<p>Do not use on elbows, knees, head, abdomen. Do not sandwich your hands and feet between the massage rollers to avoid injury and discomfort.</p>
	<p>Do not use it when wearing hard objects, such as hair accessories, in case of injury.</p>
	<p>Do not put your head and hands under the legrest and under the chair to avoid accidents or injuries.</p>
	<p>In the event of a power failure, please immediately turn off the power switch and disconnect the power plug from the outlet to avoid accidents when the power is reapplied.</p>
	<p>When unplugging the power plug, please hold the plug part on the front side and do not pull the power cord. It may cause electric shock or short circuit, which may cause fire.</p>
	<p>When the chair is not in use, please unplug the power plug from the socket, as the dust and moisture will cause wires to age and cause a leakage fire.</p>
	<p>When performing maintenance, please unplug the power plug from the socket. In addition, do not insert or remove the plug with wet hands, as it may cause electric shock and injury.</p>
	<p>Do not place it in a humid place such as a bathroom, as it may cause electric shock, fire, failure, and rust.</p>
	<p>With the exception of service technicians, no one should disassemble, repair, or modify the chair. Doing so may cause fire or electric shock.</p>

Chair Installation

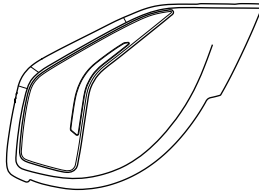
Remove main body and accessories from the packing box

Main Body

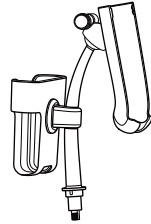


Accessories

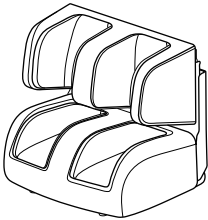
Left/Right Side Panel



Remote Control Bracket



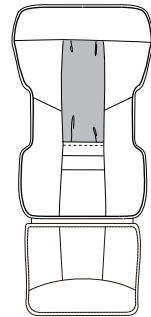
Foot Massager



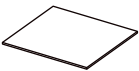
Headrest



Backrest Cover



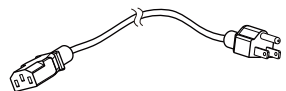
Manual Book



Kits



Power Cord



Chair Installation

Installation Guideline

I. Installation of side panels

1. Install air bags into the air inlet connector which must be connected with the corresponding colors; then connect the two wires, and fix it tightly with a wire harness after the connection. Figure ①

※ After connecting the wire with light plate, lock and fix it with a fixed button.

2. Fix the two inner hooks of side plate to the base frame first, push back from front to back, and fix the tenon at the shoulder. Figure ② ; Then use the hexagon socket screw to lock. Figure ③

Figure ①

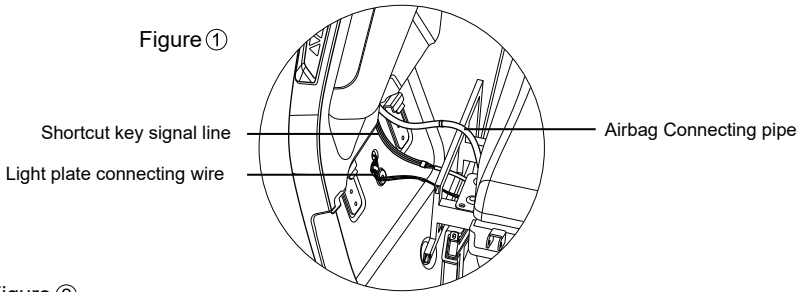


Figure ②

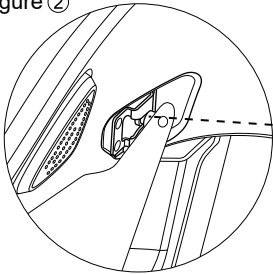
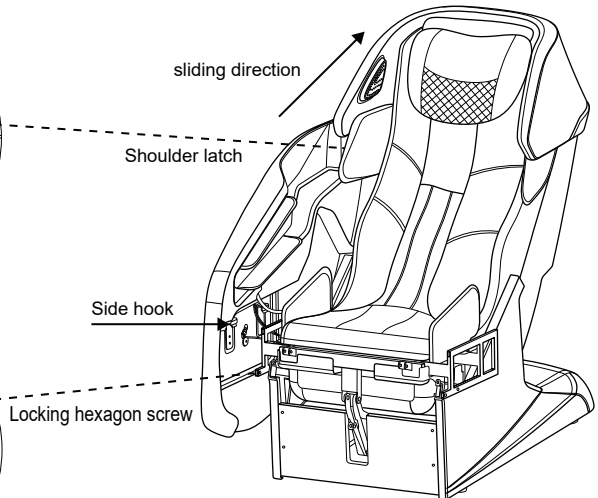
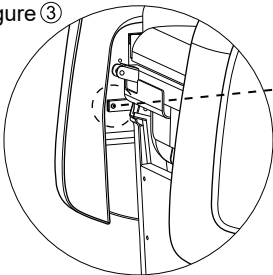


Figure ③



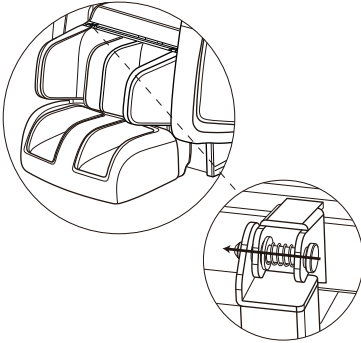
Chair Installation

Installation Guideline

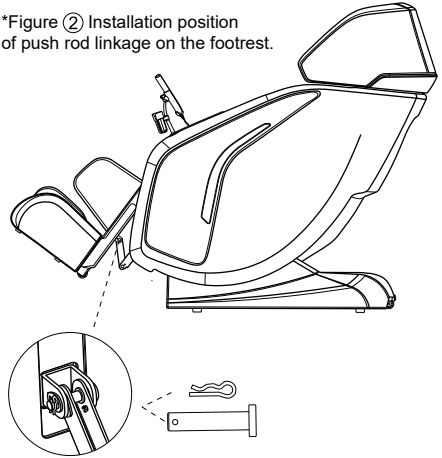
II. Installation of Foot Massager

1. Align the foot machine with the connecting holes on both sides of the seat and insert rivets and plug. Figure ①
2. Use rivets and plug to dock the seat bottom putter with the foot machine putter. Figure ②
3. Install air bags into the air inlet connector (TWO connectors) which must be connected with the corresponding colors and fix with wire harness. Then connect THREE wires, and use the zipper cloth to cover after connecting.
4. Connect the seat cushion to the zipper on the footrest.

*Figure ① Installation position of the foot machine.

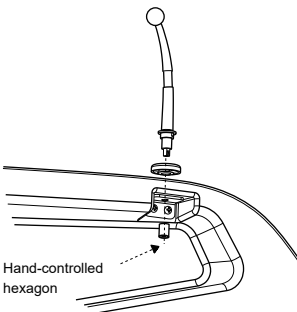


*Figure ② Installation position of push rod linkage on the footrest.

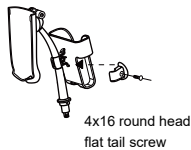


III. Installation of Remote Control Bracket

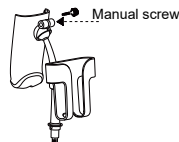
Step 1



Step 2



Step 3



1. Use Hand-controlled hexagon to lock the remote control bracket.
2. The mobile phone holder and its cover are attached to the remote control bracket by using 4x16 round head flat tail screw.
3. Use manual screw to fix the control box seat.

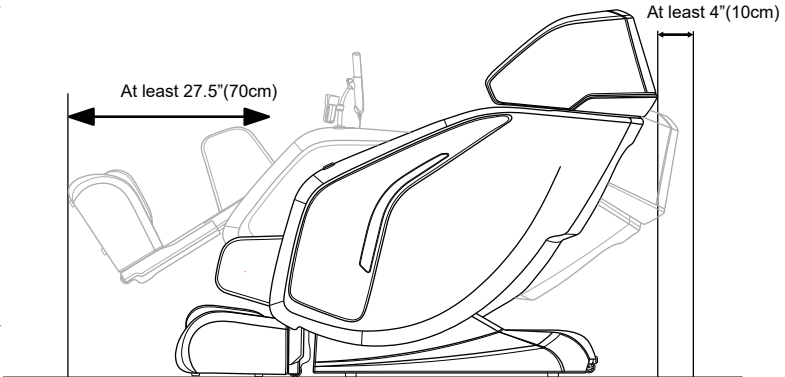
Chair Installation

Massage Chair Placement

Please place the massage chair in a flat place, and space should be left around the chair.

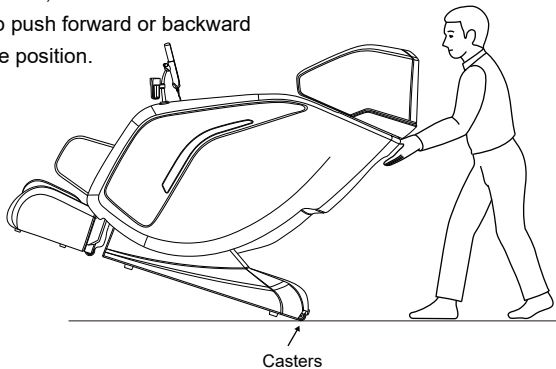
When placing the massage chair, be sure to leave enough space around the chair so that the legs and backrest of the chair can rise and fall freely.

It is recommended to place a cushion under the product to avoid damage to the ground or carpet.



Moving the Chair

As shown on the picture below, tilt the chair back about 45° and use the casters to push forward or backward carefully to the appropriate position.

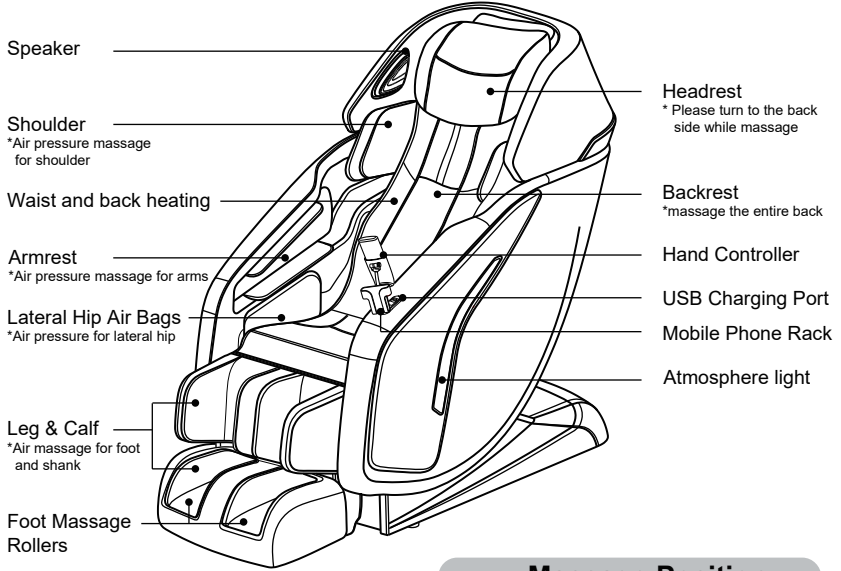


Please Note!

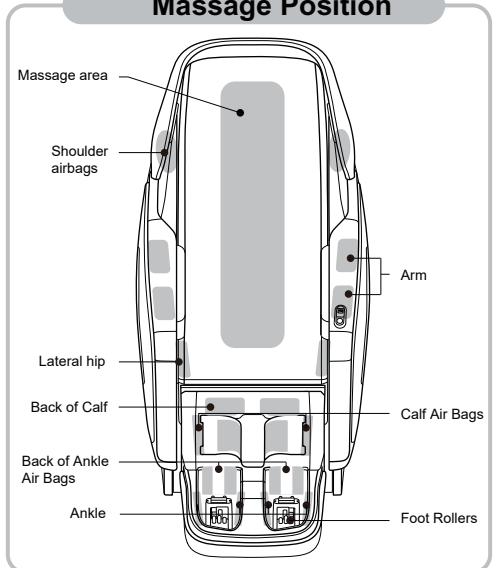
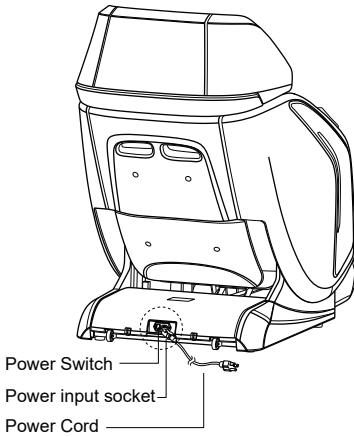
- Do not move the massage chair while someone is lying on the massage chair.
- Do not lift the seat and legrest while moving.
- When moving, please place the controller on the seat cushion to prevent it from falling to the ground.

Names of parts and function

Massage Chair



Massage Position



Names of parts and function

Controller

LCD screen

Display the corresponding message

Auto Modes Button

10 Auto massage programs for choice:

- Fatigue relief
- Refreshing
- Should relief
- Waist & hip relaxation
- Vitality
- Soothing sleep and relax
- Stretch and relax
- Japanese mode
- Thai massage
- Ancient Secret

Manual Modes Button

6 manual massage programs for choice:

- Knead up
- Knead down
- Tapping
- Kneading & tapping
- 3D tapping
- Rolling Acupressure
- Manual massage off

ON/OFF

To turn on/off and storage massage chair

Menu key

To adjust massage

Seat posture adjustment

Adjust seat back and leg angles
The chair back and legs are linked

Air massaging mode

6 air massage programs for choice:

- Body relaxation
- Relaxation
- Circulation
- Shoulder air pressure
- Hand air pressure
- Feet air pressure
- Air pressure off

Pause

Press this button, stop massage immediately

Zero gravity

Press this button, adjust massage chair to zero gravity posture

Direction buttons

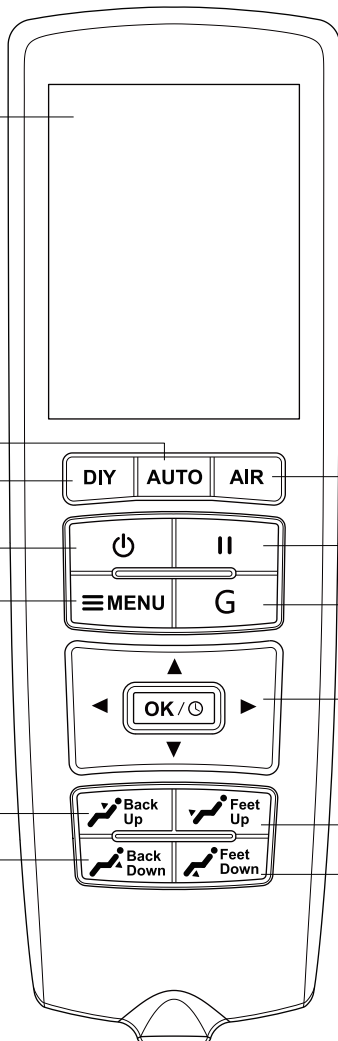
for any self operation

「OK / ⏻」 button

Decide the choice you make / go to the main page use the OK key to select the adjustment time

Leg up/down button

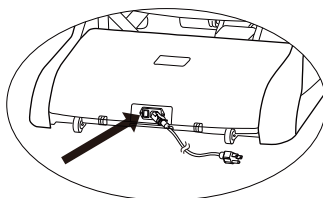
To adjust the leg angles



Before Each Massage

Connect to the Power

1. Plug the power plug into the socket
2. Turn on the power switch
(It is located below the back of the seat.)



Items to Check

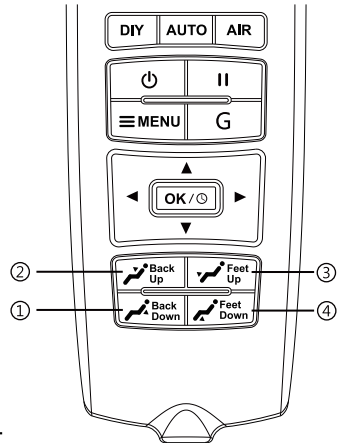
1. Check the surroundings
 - Confirm that there are no people, no pets, and no objects around the back of the massage chair or below the legrest.
2. Check the massage chair status
 - Lift the back pad and inspect the back cover and other parts for damage.
 - Even if the damage is small, stop using it immediately, unplug the power plug, and entrust repair.
 - Check the power cord, remote control cord, and power plug for damage. Also check if the power plug is stuck with hair or dust.
 - Before sitting down, please confirm the position of the massage rollers are located in the storage position (retracted at the top of the backrest).
 - Before sitting down, please also confirm the position of the legrest. If the legrest is in the raised status, forcibly sitting down can cause injuries.
In this case, press the quick button to lower the footrest.
※ Press the on/off button, the backrest will also be reset.

Adjustment method of Chair


Sitting Posture Adjustment

Up and down the seat / back / foot

1. Down the backrest, press the " Back down"
 - Long pressing the back down button, back down and foot up.
 - The bigger the angle is, the stronger the stimulation of massage ball is.
2. When straightening the back of chair,press the back up button.
 - Long pressing the back up button, straighten the back and leg down.
3. Up the leg, press the "feet up" button.
 - Long pressing the " feet up" button, leg up.
4. Put down the leg, press the "feet down" button.
 - Long pressing the " feet down" button, leg down.



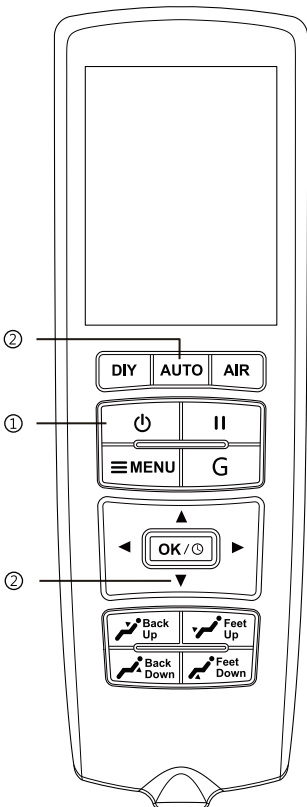
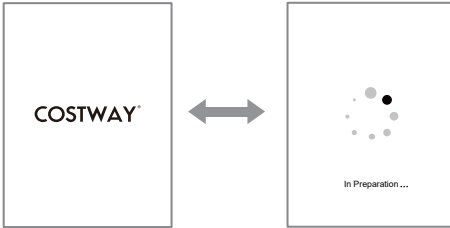
Please Note!

- Please do not sit on the backrest, armrests, legrest, shoulders to prevent the user or massage chair from tipping over, resulting in an accident or injury.
- When laying down the back of the chair or lowering the legrest, please make sure that there are no people, no pets, and no objects behind and below the legrest. 

Automatic Massage Programs

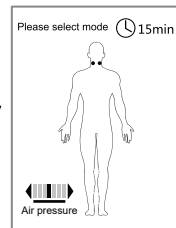
At the beginning

Connecting the power of the chair. Press the on/off button, the initial touch screen displays as below.



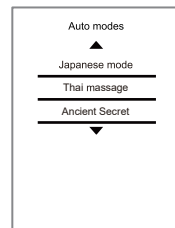
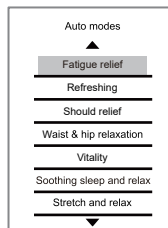
① Press the power button.

- Display standby screen.
- Please relax and sit completely in the chair. Rest your head on the back .

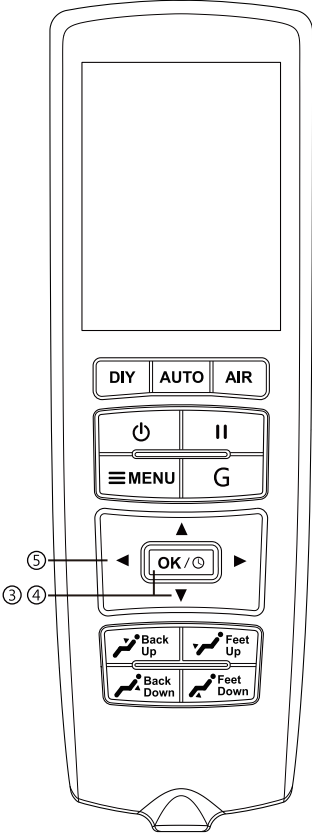


② Press the "Auto" button to display the following 10 automatic massage program functions.

Using to select your favorite program and press "OK".

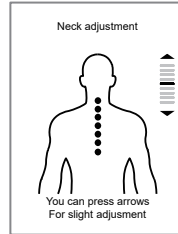
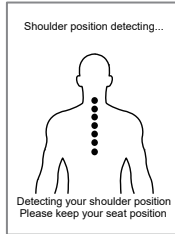


Automatic Massage Programs

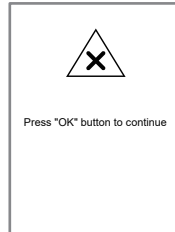


③ After the automatic mode is selected, the massage chair will first perform shoulder position detection.

- The shoulder detection page is shown in the figure below. After the shoulder is detected, you can press the up and down keys to adjust and then press the "OK" button.

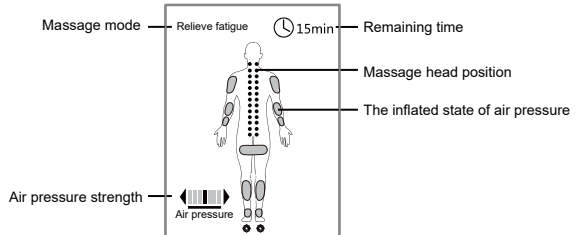


④ When no one is seated on the massage chair or when the shoulder position cannot be detected, the "Shoulder position abnormality please check again" page will appear. At this time, please press the "OK" key to retest.

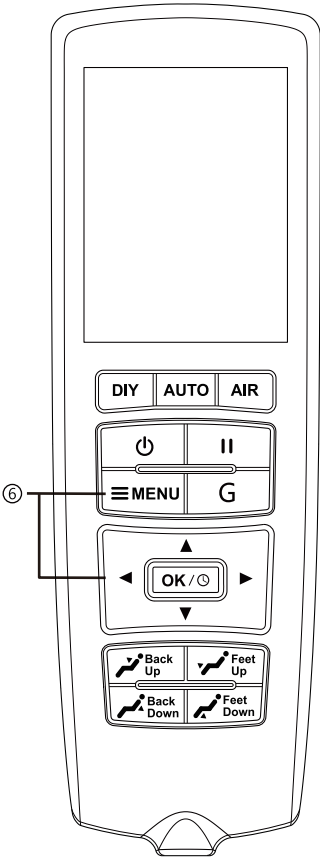


⑤ After selecting the preferred program, the LCD screen shows the automatic program in the massage.

- To adjust the pressure strength, press ◀ ▶ can adjust 7 levels of pressure strength; The initial strength is preset to "3".

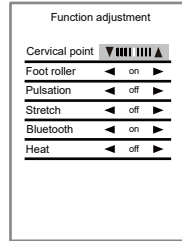


Automatic Massage Programs



⑥ To adjust in the automatic program, press the "Menu" button to enter the function adjustment page, select the required function, and then press the "OK" button.

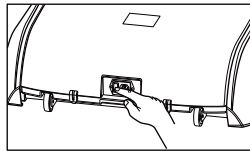
- When the cervical position is inappropriate, using the up/down arrows to adjust the most suitable position; 9 levels can be adjusted.
- Turn on or off "foot roller" using the left/right arrows to adjust; The original default is off.
- Turn on or off "Pulsation" using the left/right arrows to adjust; The original default is "off"
- Turn on or off "Stretch" using the left/right arrows to adjust, The original default is "off"



⑦ After the automatic program ends, the massage ball will automatically return to the storage position.

⑧ Please turn off the power switch after use.

- Avoid starting the massage by accidentally touching the remote control.



! Attention

Be sure to turn off the power switch after use to prevent accidents caused by children's misuse of the remote control.



Basic massage movements

Mechanical power (massage ball) massage

- **Knead up**
Massage the muscles from bottom to top.
- **knead down**
Massage the muscles from top to bottom.
- **Tapping**
Tapping the muscles to relax.
- **Kneading & tapping**
Kneading and pushing, with small movements to eliminate fatigue.
- **3D tapping**
Rhythmically continuous, hitting, adding before and after three - dimensional movement.
- **Rolling Acupressure**
Roll massage, stretch spine.

Air-pressure massage

- **The shoulder**
Focus on the shoulders and back.
- **The hand**
Focus on your hands.
- **Pulse**
After inflating the air bag, exhaust and inflate repeatedly for several times to exert rhythmic massage effect.
- **Feet**
Focus on massaging ankles and calves.
- **Strech**
The calves and buttocks are inflated with air bags. The legs of the massage chair are down, and the stretching effect is fully exerted.

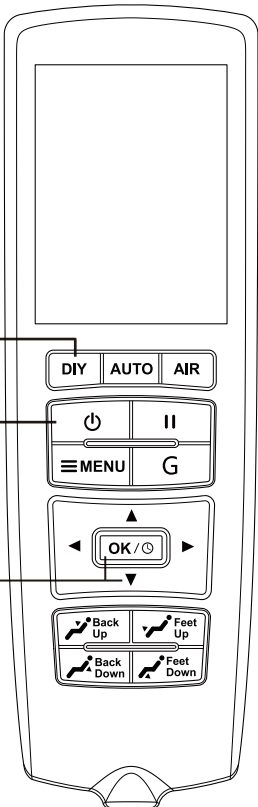
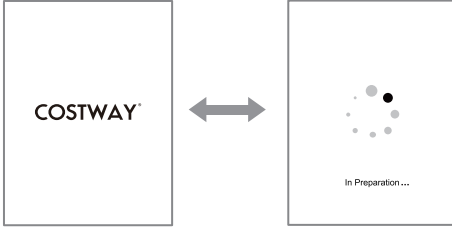
Other massage

- **Foot roller**
Foot rolling massage.

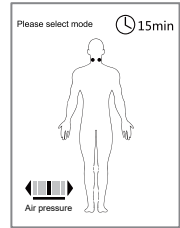
Manual Massage Programs

At the beginning

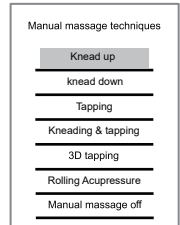
Connecting the power of the chair. Press the on/off button, the initial touch screen displays as below.



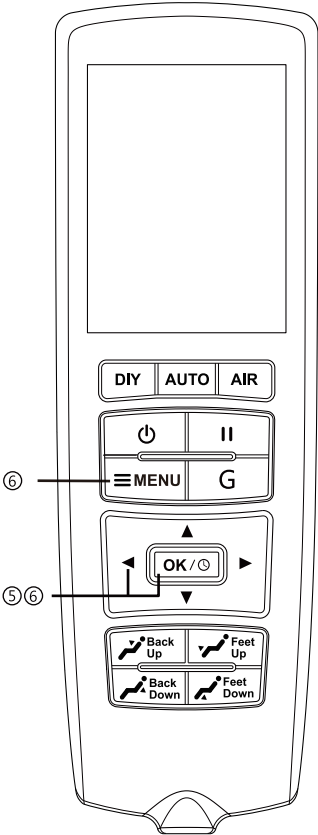
- ① Press the power button.
 - Display standby screen.
 - Please relax and sit completely in the chair. Rest your head on the back .



- ② Press the "DIY" button to display the following 6 functions of the manual massage program.



Manual Massage Programs

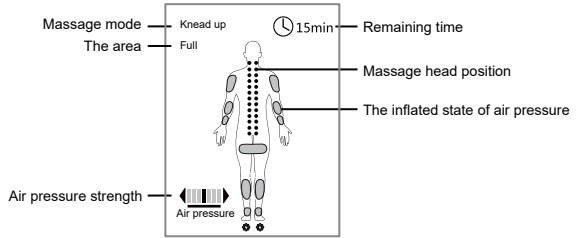


③ Using \blacktriangle \blacktriangleright to select your favorite program and press "OK".

④ To turn off the manual massage program function, using \blacktriangle \blacktriangleright to select the technique to close and press the "OK" button.

⑤ After selecting the preferred program, the LCD screen displays the manual program in the massage.

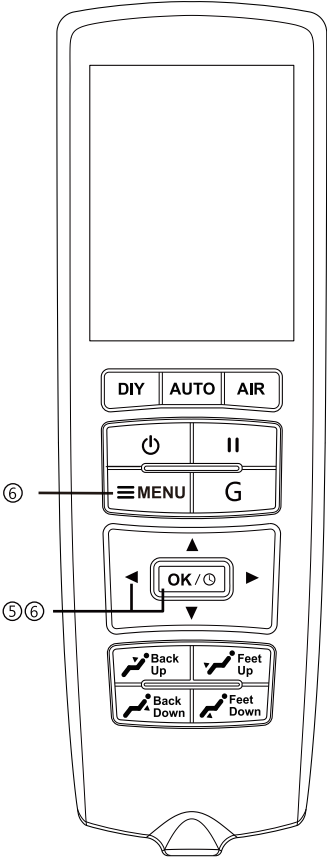
- To adjust the pressure strength, press \blacktriangle \blacktriangleright can adjust the pressure strength of 7 levels of the initial strength preset to "3".



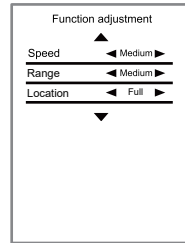
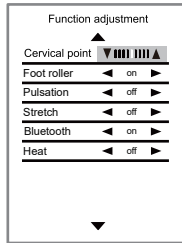
⑥ To adjust in manual program, press the "menu" button to enter the page of function adjustment. Use the \blacktriangle \blacktriangleright button to select the desired functionality, and then press the "OK" button.

- When the cervical position is inappropriate, using \blacktriangle \blacktriangleright to adjust the most suitable position; 9 levels can be adjusted.
- Turn on or off "foot roller" using \blacktriangle \blacktriangleright to adjust ; The original default is off.

Manual Massage Programs



- Turn on or off "Pulsation" using ◀ ▶ to adjust ;The original default is "off "
- Turn on or off "stretch" using ◀ ▶ to adjust, The original default is "off ".
- Use ◀ ▶ to adjust the massage speed, adjustable "fast, medium and slow" ; The initial default is medium.
- Use ◀ ▶ to adjust the width, adjustable "width, medium and narrow" ; The initial default is medium.



- ⑦ After the manual program is over, the massage ball will automatically return to the storage position.
- ⑧ After use, please turn off the power switch.
 - Prevent the touch controller from being touched accidentally and start the massage

Attention

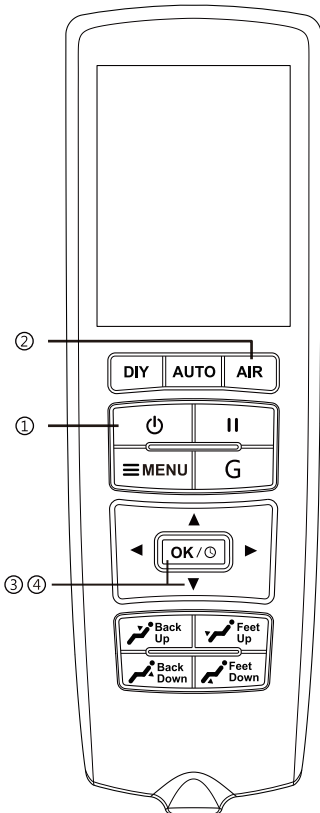
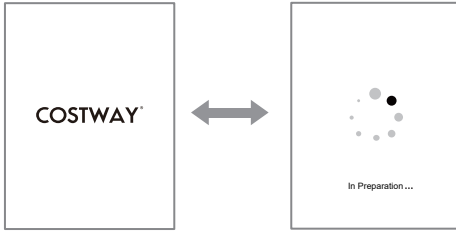
Be sure to turn off the power switch after use. To prevent children playing wrong operation accidents caused by remote control.



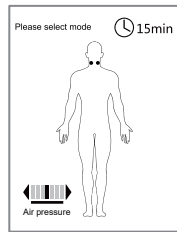
Air Pressure Programs

At the beginning

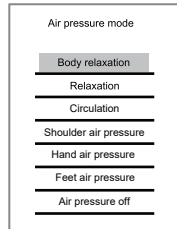
Connecting the power of the chair. Press the on/off button, the initial touch screen displays as below.





- ① Press the power button.
 - Display standby screen.
 - Please relax and sit completely in the chair. Rest your head on the back .



- ② Press the "AIR" button to display the following 6 air pressure massage program functions.

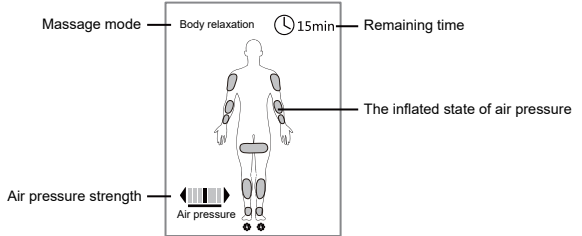


- ③ Using  Select your favorite program and press "OK".
- ④ If you want to close the air massage program function, you can use  to select air pressure off and press the "OK" button.

Air Pressure Programs

⑤ After selecting the preferred massage combination, the screen displays the manual air pressure program currently in the massage.

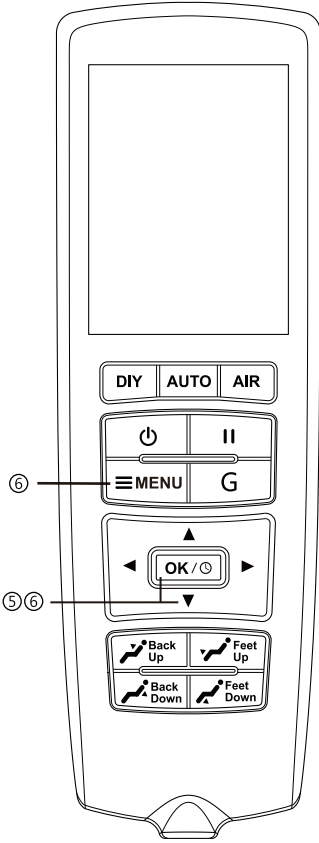
- To adjust the pressure strength, press ◀ ▶ can adjust the pressure strength of 7 levels of the initial strength preset to "3".



⑥ When adjust pressure, press "menu" button to adjust. Use the ◀ ▶ button to choose function, and press "OK" button.

- Turn on or off "foot roller" using ◀ ▶ to adjust ; The original default is off.
- Turn on or off "Pulsation" using ◀ ▶ to adjust ; The original default is "off "
- Turn on or off "stretch" using ◀ ▶ to adjust, The original default is "off ".

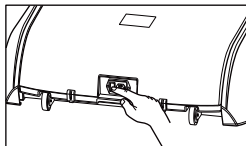
Function adjustment		
Foot roller	◀ on ▶	
Pulsation	◀ off ▶	
Stretch	◀ off ▶	
Bluetooth	◀ on ▶	
Heat	◀ off ▶	



⑦ After the program finishes, the massage rollers automatically return back to the storage position.

⑧ After use, please turn off the power switch.

- Prevent the touch controller from being touched accidentally and start the massage



! Attention

Be sure to turn off the power switch after use to prevent accidents caused by children's misuse of the remote control.



Other Functions

1. Bluetooth

Turns on bluetooth on the phone, connects to the bluetooth name EW-16007, and the music played by the mobile phone player will be played through the voice box of massage chair.

2. Timing

Entering the main page, press the OK key to select the desired time.

Available duration types: (5min, 10min, 15min, 20min, 25min and 30min).

Stop the massage halfway

Press ON/OFF

- The massage rollers will return to the storage position.

Press PAUSE

- The massage rollers will stop at the current position.

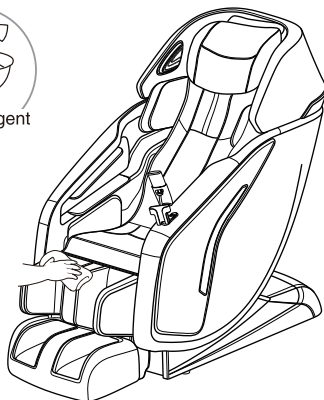
Cleaning and Storage

Cleaning Instructions

Cleaning the Chair Synthetic Leather

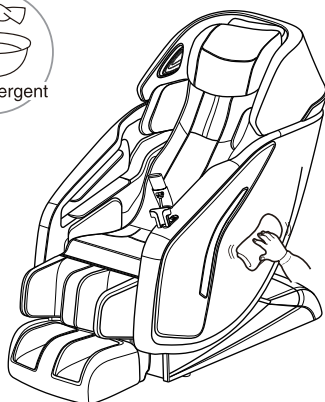
Wipe off the synthetic leather with a soft dry cloth.

- Do not clean the product with chemicals such as thinners, gasoline and alcohol.
- When using a leather maintenance product (i.e. cleaning cloths) sold on the market, follow its directions for use.
- If the synthetic leather is very dirty, try the method below.
 1. Soak a soft cloth into a solution of 3% to 5% neutral detergent and hot water. Wring it out.
 2. Wipe the surface of the synthetic leather with the moist soft cloth.
 3. Wipe the detergent residue off of the chair with a soft cloth that has been soaked in clean water and wrung out.
 4. Allow the synthetic leather to air dry on its own.
 - If the stains are difficult to remove with the method above, soak a piece of melamine foam into a neutral detergent and use it to wipe the product.
 - Do not dry the surface using a hairdryer.
 - Fabric colors may dye the surface of the synthetic leather, be careful when wiping the product with denim or colored cloth.



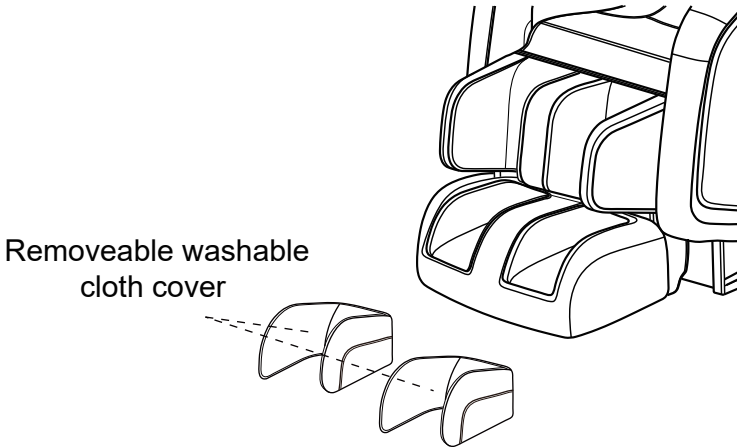
Cleaning the plastic parts

1. Soak a piece of soft cloth in hot water or neutral detergent mixed with hot water, wring it out and wipe the plastic parts.
 - Do not clean the product with chemicals such as thinners, gasoline and alcohol.
2. Wipe residue away with a clean soft cloth that has been soaked in clean water and wrung out.
 - Wring the cloth out thoroughly before using it to wipe the remote controller.
3. Let the plastic parts air dry.



Cleaning the cloth parts

- Remove the foot cloth covers from the chair
- Hand wash and let it air dry
- Re-attach the foot cloth covers to the chair



Storage

After wiping off stains and dust, store the chair in a dry place. If not in use for a long time, please put on a protective cover to prevent the dust.

Note: Do not leave in direct sunlight for a long time. Do not place the chair near high temperature places such as heaters, stoves to avoid discoloration and deterioration.

Troubleshooting



Never disassemble, repair or modify the chair without permission. This may cause sparks or injuries due to abnormal operation.

During the massage, the following sounds or feelings are caused by the structure, they are not abnormal, and they'll have no effect on the service life.

- The sound of the massage rollers moving up and down.
- The sound of gears and motors during massage.
- Friction sound of massage rollers and chair cover (especially when kneading massage).
- The sound of tapping and circular massage (especially when moving from the shoulder to the back).
- Due to the different ways of applying force to the massage rollers during kneading, tapping and circular massage, the massage speed may change.
- Different massage speeds cause different sounds.
- Motor noise of increased load.
- In the automatic program, the sound of the massage rollers automatically adjusted forward and backward for matching the user's body shape (cooing).
- The sound of inflation and deflation during air pressure massage.
- The sound of friction (squeak) from the backrest and seat when lifting the reclining chair.
- The left and right massage rollers have different heights. (Due to the massage design of alternating left and right tapping, it is inevitable that the height of the massage rollers is different, which is not a malfunction.)


Fault Phenomenon	Fault Cause	Troubleshooting
Massage Chair does not respond	Does the power plug come off?	Insert the power plug into socket.
	Is the power switch below the back of the seat turned off?	Turn on the power switch.
Massage Chair pause or stop sometimes (Controller doesn't work properly)	Does the chair's back rest against a wall or other object?	Move the massage chair to ensure there is adequate space around it. Turn off the power switch below the back of the seat, and then turn it on again.
	Is excessive force placed on the chair? (To ensure safety, when the massage rollers receive abnormal external force, the massage chair will automatically activate the safety device to stop all massage functions.)	Leave the chair, turn off the power switch, then turn it on again. Select a function and re-start.
The backrest cannot be declined or lifted	Does the power plug come off?	Insert the power plug into socket.
	Does the chair's back rest against a wall or other object?	Move the massage chair to ensure there is adequate space around it.

When an abnormal page appears on the screen, click confirm or the page will be closed after 10s.

- When the above measures still do not work, please turn off the power and unplug the power plug, then consult the seller.

Maintenance

Maintenance

<p>If you haven't used it for many years, be sure to ask for maintenance before use</p>	<p>Check if the following phenomena occur?</p> <ul style="list-style-type: none"> • Burnt smell • The power cord and plug are abnormally hot • Intermittent power when moving the power cord • Other anomalies 		<p>To prevent malfunctions or accidents, turn off the power and unplug the power plug. Be sure to entrust a dealer to inspect and repair it.</p>
--	--	---	--

Product specification

Product name		Zero Gravity Massage Chair
Product model		EW-16007
Rated	voltage	120V~ 60Hz
	time	15min
	power	230W
Massage rollers speed	kneading	3 levels
	tapping	3 levels
Air pressure massage intensity		7 levels
Arm air pressure massage intensity		7 levels
Auto-timer		15min preset; 5min, 10min, 15min, 20min, 25min, 30min can be adjustable
Seat adjustable angles	Backrest	About 106° ~ 132°
	footrest	About 0° ~ 46°
Size	standing	L*W*H 63*32*47 inch / 160*81*119 cm
	lie down	L*W*H 71*32*42.5 inch / 180*81*108cm
Product weight		287 lbs/130kg(G.W) 231lbs/105kg(N.W)

※ This massage chair must not be used with voltages other than the rated voltage.

Welcome to visit our website and purchase our quality products!

With your inspiring rating, COSTWAY will be more consistent to offer you
EASY SHOPPING EXPERIENCE, GOOD PRODUCTS and EFFICIENT SERVICE!

US office: Fontana, California

UK office: Ipswich



- * Reward Points
- * Exclusive Customer Service
- * Personalized Recommendations
- * Permanent Shopping Cart
- * Order History

5 Star Rating



We would like to extend our heartfelt thanks to
all of our customers for taking time to assemble
this product and giving us valuable feedbacks.

*THANK
YOU*
☺





Costway Massage Chair Customer Warranty

Costway products include the following warranty:

This Costway massage chair has a three-year warranty for both parts and labor.

Costway customer service will not issue Return Material Authorizations (RMAs) for products due to buyer's remorse. RMAs will be issued only when product has quality problem. Costway products will be either repaired by the customer or by an in-home technician.

Service And Technical Support:

Customers can contact Costway's customer service department at 213-401-2666 at any time Monday through Friday or via email at topsupport@costway.com for warranty or service issues.

Customers are required to provide dated proof of purchase (sales receipt) when they contact Costway service department regarding a repair.



A Costway customer service representative will attend to most customer inquiries, however, in some cases, when necessary, a technical service specialist will provide advanced support.

Non-warranty repair is provided on a "per incident" basis. Costway customer service will verify that the unit has failed and provide instructions for repairing a unit. All applicable repairs, parts, shipping, handling, local tax, and a "per incident" fee will be charged for non-warranty repairs.

You can visit www.costway.com and www.costway.ca for the latest terms and pricing depending on the type of issue or incident.

Proof of purchase (sales receipt) is required for all warranty repairs or service.

Extended Warranties:

Costway offers extended warranty programs to enhance ownership of Costway products.

Extended warranty provides: A maximum 2-year limited repair or



replacement massage chair warranty with on-site service in certain areas.

Please visit www.costway.com and www.costway.ca for the latest terms for extended warranties.

Product Repairs

Many Costway product repairs may be performed by the customer in their own home with parts and instructions supplied by Costway, such as remote controller replacements that don't require a technician.

Customers may contact Costway's customer service department at topsupport@costway.com for warranty or service issues.

Floor Models and Demonstration Units have a prorated warranty period that begins the day the model is placed on the floor and connected to an electrical outlet by the retail partner. Proof of purchase (sales receipt) is required in order to obtain warranty service and parts. Non-warranty parts and service are available at a "per incident" rate.

Warranty Coverage Period: Warranty coverage begins on the date of customer purchase. Proof of purchase (sales receipt) is required for all



warranty repairs. The warranty period is measured by continuous calendar days based on a seven-day week.

Field Service: The Costway customer service department will diagnose the problem and schedule an authorized service provider to repair a chair in the customer's residence. If the area is not covered by Costway official or authorized service provider, after the Costway service team diagnose the problem and provide approval, customers may find their own qualified technician. Customers will be reimbursement once an invoice and proof of the technician's qualifications are submitted to the Costway customer service department. The value of reimbursement should not exceed the cost of a Costway official or authorized service provider.

Parts: All parts deemed necessary for repairs will be shipped to the customer at no charge.

CUSTOMER WARRANTY LIMITATIONS AND EXCLUSIONS

Warranties are not valid in certain areas. Invalid areas in Canada: NT, NU, YT.



Postcodes start with AOK, AOP, AOR, A2V, GOG, G4T, JOM, ROB, TOP, TOV, VOT, VOL, VOV, VOW, XOA, XOB, XOC, XOG, XOE, X1A, YOA, YOB, Y1A.

Invalid areas in US: Alaska, Hawaii, Puerto Rico, and Guam.

The warranty only applies to Costway products and does not include any accessories or enhancements.

Field service requires pre-approval and must be performed by qualified technicians. Costway official and authorized field service is only available in certain areas. Please visit www.costway.com and www.costway.ca for the latest information regarding authorized field service.

Softening of foams and filling composites in pillows, pads, and memory foam occurs naturally and does not constitute a defect under this warranty.

Fading, wear, and piling of fabrics occurs naturally and does not constitute a defect under this warranty.

Natural markings, grain, and dye variations in leather do not constitute a defect under this warranty.

Warranties do not cover any loss or damage resulting from improper installation, unauthorized repairs or modifications, improper use of electrical/power supply, loss of power, dropped products, a malfunction of or damage to an operating part from failure to provide manufacturer's recommended maintenance, transportation damage, theft, abuse, misuse, neglect, vandalism, or environmental conditions (fire, floods, rust, corrosion, sand, dirt, windstorms, hail, earthquakes, or exposure to other weather conditions), loss of use during the period the product is at a repair facility, or otherwise awaiting parts or repair.

Damage due to shipping and handling does not constitute a defect under this warranty.

Under no circumstance shall Costway or its representatives be liable for indirect, consequential, or incidental damages (including damages for lost profits, business interruption, bodily injury, medical harm, and the like), even if any party has been advised of the possibility of such damages.

Warranties are non-transferable and shall be in lieu of any other warranty, express or implied, including but not limited to any implied



warranty or merchant ability or fitness for particular use.

Costway's sole liability and the purchaser's exclusive right shall be for the repair, or at Costway's option, for the replacement of defective part.

Notwithstanding the above, if replacements parts for defective materials are not available, Costway reserves the right to make substitutions in lieu of repair or replacement.

All warranties begin on the date of purchase; no allowance or extension is offered for delivery and/or installation.

Warranties do not apply to rental, business, commercial, institutional, or other non-residential users.

Extended Warranty

LIMITED REPAIR OR REPLACEMENT MASSAGE CHAIR WARRANTY WITH
ON-SITE SERVICE

If you have a warranty or product question, please contact Costway's support team at 213-401-2666 at any time Monday through Friday, or via email at topsupport@costway.com.



In the event you detect and report a defect in the workmanship or material of the Equipment, during the Service Period, then the Administrator shall provide the services hereinafter described.

Your purchase of the Extended Warranty shall constitute your acceptance to the terms of this Limited Warranty including the indemnification provisions.

1) DEFINITIONS - For the purpose of this Limited Warranty, the following terms shall have the following meanings:

- (1) "Equipment" shall mean a Costway product or system;
- (2) "Customer" shall mean only the residential end-user of the Equipment who is the original purchaser of the equipment from the Distributor, from an authorized reseller.
- (3) Usages of "you" or "your" refer to the Customer;
- (4) "Commencement Date" shall mean the date on which the Equipment is first purchased by a Customer from the Distributor or from an authorized reseller;
- (5) "Service Period" shall mean the period commencing on the Commencement Date;



(6) "Administrator" shall mean Costway. Usage of "we," "us," or "our" shall mean the Administrator. You may contact the Administrator if you have questions regarding this coverage. We can be reached by phone at 213-401-2666.

2) COVERAGE - During the Service Period, we will repair or replace, at our sole discretion, any defective Equipment. We will return the Equipment to a properly functioning state. To obtain such service, you must be able to provide us with the original, dated proof of purchase (sales receipt) for the Equipment. This Limited Warranty extends only to Customers. Only our representatives may perform repairs on the Equipment under this Limited Warranty. Replaced parts shall be covered under this Limited Warranty for the remainder of the Service Period or for thirty (30) days, whichever is longer. We will provide on-site service as necessary on regular workdays. Submission of the Extended Warranty Card form is not a condition precedent to obtaining service under this Limited Warranty. If a particular replacement part is not available from the manufacturer, we will make reasonable efforts to locate a compatible replacement part. If we are unable to locate a compatible part, we may replace your Equipment with a similar product. Under no circumstances



shall the retail replacement value exceed the original net price paid for the Equipment. In the event you choose not to accept a replacement for your Equipment, we shall no longer be responsible for making repairs under this Limited Warranty.

3) EXCLUSIONS - This Limited Warranty does not include service needed on Equipment as a result of any of the following:

- (1) Installation, set-up, moving, or relocation from the originally installed location;
- (2) Cosmetic changes, tears, or failure of fabrics, woods, foam, pads, plastics, upholsteries, exterior coverings, and damages and changes resulting from normal wear and tear;
- (3) Negligence, misuse, abuse, improper maintenance, electrical disturbances and power surges, acts of nature, or work, attachments, additions, alterations, or modifications by persons other than authorized Administrator service providers;
- (4) Failure by the Customer to use a high-quality surge protector during the entire Service Period; (5) Improper operating environments;



- (6) Any problem not involving a defect;
- (7) Damage or malfunction whatsoever caused by an animal or pet;
- (8) Damage or malfunction whatsoever caused by liquids of any kind;
- (9) Rental, business, commercial, institutional, or other non-residential use;
- (10) Unnecessary service requirement. If no problem is found upon diagnosis by us or any other third party, you may be charged our standard rate for shipping costs and parts;
- (11) Dropped products or components (including remote controls);
- (12) Use of any item with the Equipment that is not designated for use with the Equipment; and
- (13) Field service requires pre-approval and must be performed by Costway's authorized field service personnel. Field service is only available in certain areas. Please visit www.costway.com and www.costway.ca for the latest information regarding field service.

4) YOUR RESPONSIBILITIES - You shall:

- (1) Operate the Equipment in an environment meeting the



requirements delineated in the Equipment's owner manual and other provided instructions;

(2) Protect the supply of electricity to the Equipment through the use a high-quality surge protection device;

(3) Permit no work on the Equipment except by our authorized service providers;

(4) Have an adult representative present whenever we provide support services;

(5) Perform telephone or email diagnostic procedures as requested by us;

(6) Safeguard and return (at our expense) all replacement parts shipped to you. Either the part to be replaced or the replacement part or item shipped to you must be returned to the Distributor upon request.

5) EXCULPATION AND INDEMNIFICATION - Our maximum liability under this Limited Warranty is limited to the cost of repairing or replacing defective Equipment. We shall not be liable to you for incidental and



consequential damages. Under no circumstances shall you or anyone else ever be deemed to be a third-party beneficiary of the agreement. We shall not be liable for, and you hereby indemnify and hold us and every authorized service provider innocent from, any and all loss, damage, claim, or cause of action, direct or indirect, incidental or consequential, occurring to you, or to the employees or agents of you, or to any other third party, or to the property of any of the foregoing, which may arise as a result of any defect covered by this Limited Warranty or as a result of any service performed under this Limited Warranty.

Exclusions:

- Any malfunction that is caused by circumstance beyond Costway's control.
- Damage or malfunction resulting from misuse or abuse including, but not limited to, damage from liquids of any kind, transit, shipping, relocation damage, incorrect voltage, operation contrary to what is detailed in the Owner's Manual, modification or repair by the user, use by anyone (whether the product is open or stowed) over weight capacity, or any use by more than one person at a time, outdoor usage, and any flood, fire, or other Acts of God.
- Normal wear and tear and all cosmetic damage to fabric or other exterior parts of the chair.



- Under no circumstances whatsoever shall Costway be liable for special, incidental, or consequential damages.

- Rental, business, commercial, institutional, or other non-residential use